

# **E-Z CUT INC.**

## **MK-7 CARPET CUTTING MACHINE**

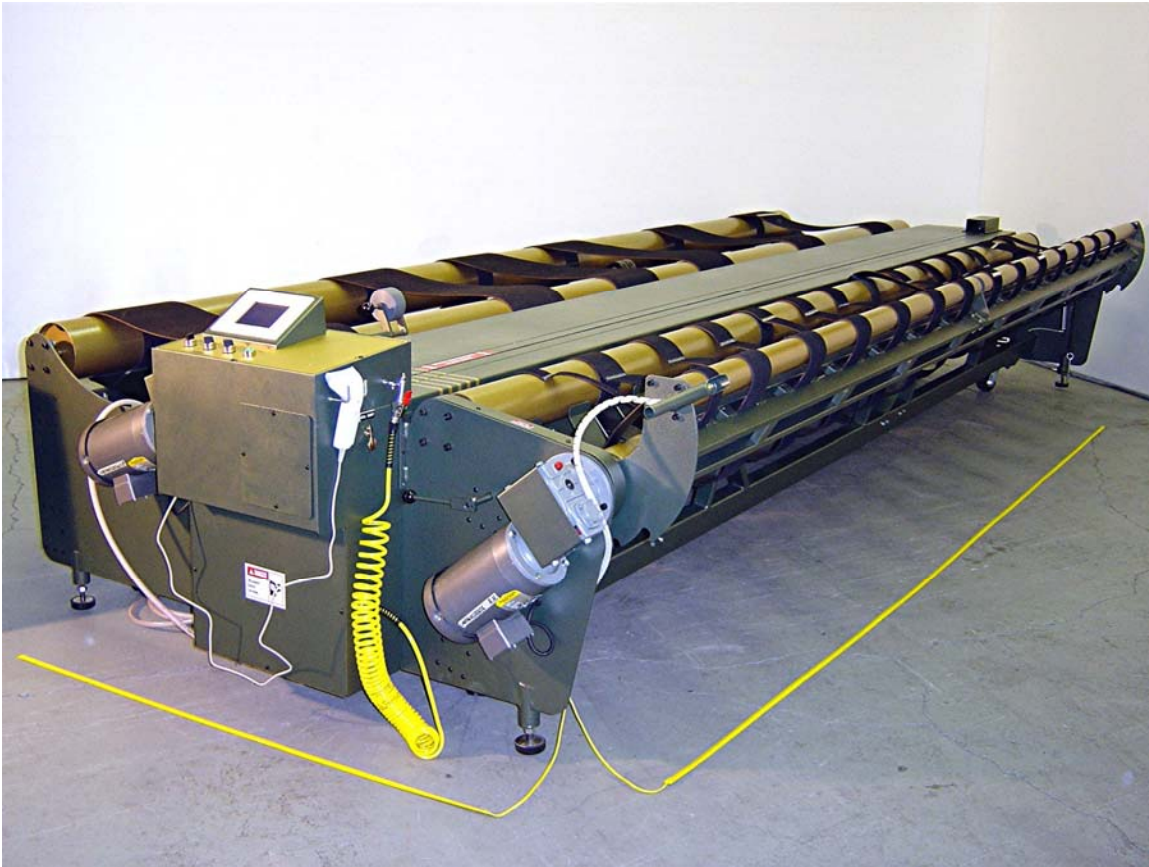

## **OPERATING MANUAL**

REV 3.2

## CONTENTS

<b>INTRODUCTION.....</b>	<b>3</b>
<b>MACHINE'S ARRIVAL &amp; PREPARATION .....</b>	<b>3</b>
<b>MAIN OPERATING PROCEDURES.....</b>	<b>7</b>
<b>REVERSE ROLLING PROCEDURES .....</b>	<b>13</b>
<b>VINYL PROCEDURES .....</b>	<b>15</b>
<b>CARPET SHUTTLE CONTROL SYSTEM.....</b>	<b>16</b>
<b>IMPORTANT SAFETY AND MAINTENANCE TIPS.....</b>	<b>18</b>
<b>ROUTINE MAINTENANCE SCHEDULE .....</b>	<b>19</b>
<b>RECORD OF MAINTENANCE .....</b>	<b>21</b>
<b>GEARBOX OIL REPLACEMENT .....</b>	<b>22</b>
<b>TROUBLE SHOOTING MEASURING ACCURACY PROBLEMS.....</b>	<b>23</b>
<b>CALIBRATING OPTIONS ON YOUR TOUCH SCREEN COUNTER .....</b>	<b>25</b>
<b>ADJUSTING THE COUNTER PRESSURE WHEEL .....</b>	<b>27</b>
<b>BLADEHOLDER INSTRUCTIONS .....</b>	<b>28</b>
<b>OPERATING THE TOUCH SCREEN PANEL.....</b>	<b>29</b>
<b>WARRANTY.....</b>	<b>35</b>

## INTRODUCTION

- Read these instructions carefully and thoroughly so as to ensure that you are familiar with the machines features, general operating functions and the safety and maintenance requirements.
- Only authorised personnel who are familiar with the machine and its operation should use it. Never allow children near the machine.
- Keep the area of operation clear of any and all potential hazards.
- The following procedures are intended to acquaint you with the safe and efficient operation of your E-Z CUT Cutting Machine. Try to abide by the rule: "If at first you don't succeed, try again". This machine is a proven tool for improving your warehouse and cutting efficiency. Take your time, be patient, and enjoy the benefits of this machine for many years to come.
- If assistance is required or if any of the following procedures are unclear, please do not hesitate to contact an E-Z CUT representative directly at **1-800-661-5156**.

## MACHINE'S ARRIVAL & PREPARATION

- Once the machine has arrived and been uncrated, raise the machine off the base of the crate with your forklift from the "broad side". Insert the forklift forks under the bottom beams (frame) of the machine and gently raise the machine.

**120 psi - 5-8 CFM  
2 H.P. Motor - 10-12 Gallon Tank**

- Once the machine's air system is charged use the "AIR LEGS" switch located on the side of the Control Panel to lift the machine onto the Caster Wheels. You can now move the machine to the desired position for operation on your warehouse floor.
- The machine should be located in a dry location and operated at room temperature. **Extreme cold or high heat and humidity** could lead to electrical problems or even damage to the electronics on your machine. See chart below for approximate temperature (**including humidity**) ranges.

COLD	35°F Or Lower	2°C Or Lower	May Cause Damage To Electronics
COOL	45°F Or Lower	7°C Or Lower	May Cause Problems With Electronics
<b>OPTIMAL</b>	<b>70°F</b>	<b>21°C</b>	<b>Optimal Operating Temperature</b>
WARM	95°F Or Higher	35°C Or Higher	May Cause Problems With Electronics
HOT	110°F Or Higher	43°C Or Higher	May Cause Damage To Electronics

**NOTE: DO NOT TRY TO RAISE OR LOWER THE MACHINE WHEN YOU HAVE MATERIAL ON THE MACHINE. THE MACHINE IS NOT DESIGNED TO ACCOMMODATE ADDITIONAL WEIGHT DURING THE RAISING/LOWERING OPERATION. DAMAGE TO THE MACHINE MAY OCCUR.**

### **FOOT SWITCH TAPE AND ELETRICAL INSTALLATION**

In the box of accessories provided with the machine, you will find three lengths of Foot Switch Tape - two lengths that are each approx. 14 feet long and one length that is approx. 5 feet long. Once installed, you will be able to activate the machine's rollers by stepping on any section of the Foot Switch Tape. Install these three sections of Foot Switch Tape around the machine as follows:

- Lay out the short length (approx. 5 feet) of Foot Switch Tape on the floor along the Front of the machine, with the plug end on the Right Hand Side. Plug this section into any one of the two mating plugs located on the Right Inside Edge of the machine's front panel.
- Lay out one of the two longer lengths (approx. 11 feet) of Foot Switch Tape on the floor along the Right Side of the machine, with the plug end closest to the front of the machine. Plug this section into the remaining mating plug on the Right Inside Edge of the machine's front panel.
- Lay out the second of the two longer lengths of Foot Switch Tape on the floor along the Left Side of the machine, again with the plug end closest to the front of the machine. Plug this section into the one mating plug located on the Left Inside Edge of the machine's front panel.

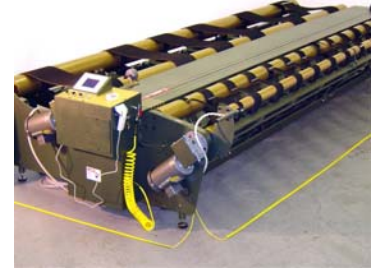
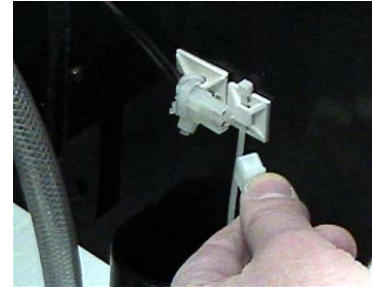

**NOTE:** Depending on your operation, the location of the machine, and whether or not you move the machine around on a regular basis, you may want to secure the sections of Foot Switch Tape to the floor with the use of duct or masking tape. By taping the Foot Switch Tape to the floor, you will avoid possible twisting of and reduce potential damage to the Foot Switch Tape. Should you need to move your machine for cleaning purposes, remove the duct/masking tape from the Foot Switch Tape, lift and drape the Foot Switch Tape sections onto the machine, and then re-secure the Foot Switch Tape to the floor with more duct/masking tape when you re-locate the machine. **DO NOT detach the Foot Switch Tape from the plug connections on the machine, as continued plugging/unplugging will cause damage to the plug ends.**

- Hook-up the machine's power cord into the following power source (Hardwired or Plug).

## 230V (Single Phase) / 60 Hz / 20 Amp

➤ The machine will go through its boot-up sequence, when complete the display will be on the START screen. Press the ENTER button to proceed. This will take you to the Main Menu. Press the “CUT” button to go to the CUT screen. To test the machine, enter a random pre-set length (feet and/or inches) by pressing the corresponding buttons and using the keypad that pops up.

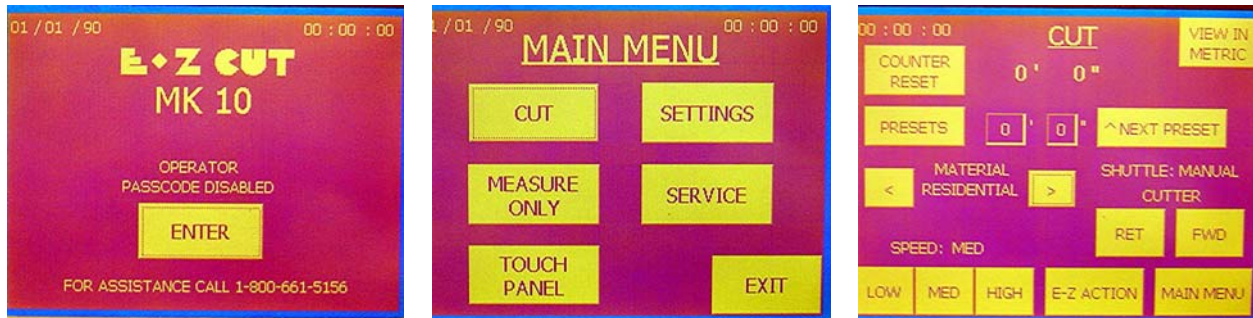

➤ Test the activation of the rollers by turning both Roller Switches to FWD and then press and hold the Jog Button. The rollers should now turn and then stop when you remove your finger from the button. Next, with the Roller Switches still in FWD, step on the Foot Switch Tape. Again, the rollers should turn and then stop when you remove your foot from the Foot Switch Tape.

➤ Check that all 3 speed levels (Low, Medium & High) of the machine are working along with both roller directions (FWD & REV).

➤ Check that the Cutting Bar is working by pushing and holding the Cutter Switch to FWD. You will hear a Warning Beeper for approximately 3 seconds prior to the Cutter being activated. This is your notice to keep hands and any other potential hazards clear of the Cutting Track. Since it is a Two-Way Cutter, you can make your next cut by pushing & holding the Cutter Switch to REV.



### **IMPORTANT NOTES:**

➤ **The Cutting Bar only takes about 3 seconds to travel the length of the Cutting Track. Should you ever have to stop the Cutter, just release the Cutter switch and the Cutter will stop immediately. Use extreme caution, care and common sense when operating this Cutter!**

➤ Be sure to use extra care and caution when loading/unloading rolls on the Left Hand Side Cradle so as to avoid damaging the two sets of "Shuttle Arms" located in the middle of this Cradle.

➤ It is best to always turn the Rollers Switches "OFF" when the machine is not in use. In addition, your machine is equipped with an "Emergency Stop" button located on the side of the control Panel. By pressing this button, you disable the machine instantly. To re-set the machine, just turn the button until it pops back out. **DO NOT USE THIS AS AN ON/OFF SWITCH. IT IS BEST TO UNPLUG THE MACHINE FROM THE WALL DAILY.**



## MAIN OPERATING PROCEDURES

### LOADING THE ROLL OF CARPET

Place the roll on the Left Hand Side Cradle and ensure that the "Feed Edge" is coming from the Bottom towards the Counter with the "Pile" facing Up. Whenever possible load rolls from the rear of the machine to avoid damaging the control panel. **Never measure with the "Pile" facing Down as this will result in inaccurate readings.** For best results turn the Left Hand Side Rollers in Reverse (REV), press the Foot Switch Tape or Jog Button, and allow the roll to rotate a few turns until it tightens.



### PREPARING TO MEASURE

Lift the Counter Weight Arm to the Up position. Advance the carpet towards the Right Hand Side by switching both the Left and Right Side Rollers to Forward (FWD), and depressing the Foot Switch Tape or Jog Button. You may find it easier to get the roll started by using the Jog Button instead of the Foot Switch Tape. Stop the advancement of the carpet at the Cutting Track and lower the Counter Weight Arm down onto the carpet.



### PROGRAMMING THE COUNTER

- From the CUTTING SCREEN enter the desired length in feet and/or inches.
- Make sure the carpet is lined up with the Cutting Track.
- Make sure the CW is lowered to its DOWN position.
- Reset the counter (press the COUNTER RESET button).

### **NOTES:**

- **These are the necessary steps to perform a single cut. The machine can perform many other functions and procedures. For a complete list of the features and how to use them see the OPERATING THE TOUCHSCREEN PANEL section on page 27 of this manual.**
- **Be sure the counter weight arm is lowered back down onto the material.**

## **STARTING THE ROLL UP PROCESS**

With both Rollers in the FWD position and the Counter Weight Arm in the Down position, advance the carpet by depressing the Foot Switch Tape or Jog Button as well as assisting the carpet by hand until it is into the Right Hand Side Cradle and stop it's progress when it advances just past the middle of the Right Hand Side Cradle (approx. 4 to 6 inches). Although it is not necessary, should you require a core, it can be placed on top of the carpet in the Right Hand Side Cradle at this time.

## **ROLLING UP THE CARPET**

- For starters, you are best to keep the machine in Low speed until you get more comfortable and familiar with how the machine works.
- With both rollers in FWD, press the Air Assist Button located at the top of the Roll-Up Handle on the Right Hand Side Cradle with your right thumb.
- Simultaneously, lift the Cradle up and over top of the carpet and release your thumb from the Air Assist Button.
- Step on the Foot Switch Tape or press the Jog Button to advance the carpet further into the Right Hand Side Cradle. You will notice that the carpet will curl over and start to re-roll itself.
- Once you have rolled up approx. 3 to 5 feet (3 to 5 turns), you can pull the Right Hand Side Cradle back to it's **Normal** locked position. **Do not press the air assist button to do this.**
- You can now increase the speed to Medium or High, whatever you are more comfortable with at this time.

## **NOTES:**

- Once you practice more and become more familiar with the machine, these steps will become more integrated and much easier to perform.
- If the carpet does not seem to want to roll up in the Right Hand Side Cradle immediately, just stop the process, reverse the carpet back a little and start over. You may have to jog/bounce the Right Hand Side Cradle Handle a little bit during the roll-up to assist in getting the carpet started. Also, if you experience "buckling" of the carpet during this process, just turn the Left Hand Side Rollers to OFF for a split-second and then back to FWD once the buckling is removed. **Be Patient It Will Work!**
- Should you prefer a more loose roll-up of your carpet, just pull the Right Hand Side Cradle Handle back earlier than after 3 to 5 turns or don't even engage the Right Hand Side Cradle at the start. **Experiment to see what works best for you.**

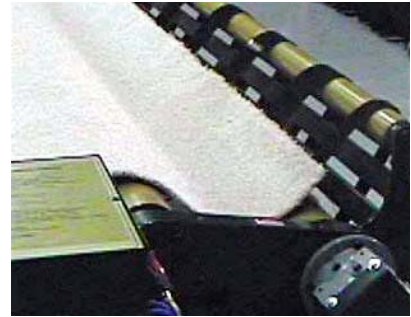



**IMPORTANT NOTE: IF YOU CONTINUE THE ROLL-UP PROCEDURE BY PRESSING THE JOG BUTTON INSTEAD OF THE FOOT SWITCH TAPE, THE MACHINE WILL NOT STOP AUTOMATICALLY AT YOUR PRE-SET LENGTH. BE SURE TO USE THE FOOT SWITCH TAPE AFTER YOU HAVE GOT THE CARPET STARTED SO THIS FUNCTION CAN PERFORM PROPERLY.**

### **ROLLING UP THE CARPET STRAIGHT**

As long as your floor and machine are level, the Adjustable Legs are even and the main roll on the Left Hand Side Cradle is rolled up relatively straight, then the carpet will roll-up fairly straight on the Right Hand Side. If any of these factors do not apply, they should be corrected immediately. Minor coning or telescoping problems can be overcome quite easily. Have the operator move along the Right Hand Side of the machine near the front corner. As the carpet continues to come across and roll-up, the operator can adjust the carpet by hand in the cradle much like he would if he were rolling it up on the floor. This procedure eliminates any serious coning and as long as the carpet rolls up relatively straight on the Right Hand Side, your cut will be straight and square.

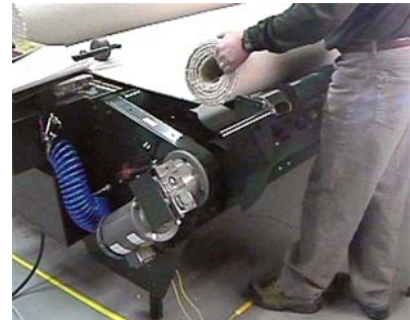

### **AUTOMATIC SLOW DOWN**

Your machine has an Automatic Slow Down Mode programmed into the Counter. If the machine is programmed for **20.00**, the machine will automatically slow down to Low speed at about **18.06** and will stop automatically at exactly **20.00**. **The Automatic Slowdown and Stop will only work if you are advancing the carpet with the Foot Switch Tape and not the Jog Button.**

**NOTE:** If you wish to give a couple of extra inches to the programmed cut, you can do so by pressing the Jog Button. If you try to step on the Foot Switch Tape, the machine's rollers will not work because they are locked out after the pre-set length is reached. To re-activate the Foot Switch Tape, press the R (reset) button on the Cut Screen.

### **PRIOR TO CUTTING**

Prior to making your cut, there may be a slight buckle of carpet on the table. To eliminate this, turn the Right Hand Side Rollers into FWD and the Left Hand Side Rollers in REV, then tap the

Jog Button.

## **CUTTING THE CARPET**

- Turn Both Rollers Switches to the "OFF" positions - **VERY IMPORTANT!**
- Clear the area of any potential hazards (i.e. someone may be leaning on the machine or have their hand in the path of the Cutting Bar).

From the Cut Screen push and hold the Cutter “RET” or “FWD” Button (depending on which direction you need to go) to activate the cutter.

- A warning beep will sound for approximately 3 seconds before the Cutter will start.
- Once the Cutter has completed the cut, release the Button
- Because it is a Two-Way Cutter, you do not have to return the Cutting Bar back to the home end of the machine for the next cut.



**NOTE: Use extreme caution and common sense when activating the cutting bar. Should you need to stop the cutting bar's progress at any time during a cut, just release the toggle switch immediately.**

## **WRAPPING THE ROLLS**

To wrap your cut piece, turn the Right Hand Side Rollers to FWD and the Left Hand Side Rollers to OFF. Secure your stretch film or plastic under the edge of the carpet, step on the Foot Switch Tape along the Right Hand Side of the machine, and wrap the roll accordingly. The same can be done to the balance roll on the Left Hand Side by turning the Left Hand Side Rollers in REV and the Right Hand Side Rollers to OFF.





## **REMOVING/DUMPING ROLLS FROM THE MACHINE**

Once cutting and wrapping is complete, you can now remove the cut piece from the machine's Right Hand Side Cradle without the need of a lift truck. Switch both the Left Hand Side and the Right Hand Side Rollers to OFF. Press the Air Assist Button on the Right Hand Side Cradle Handle and gently lower the cradle to its **down** position. Push the roll off of the machine and return the Right Hand Side Cradle to its **Normal** locked position

**NOTE: Heavier rolls and cuts should be removed with a lift truck, and not by way of the Dumping Mechanism, for safety and to avoid damage to your machine.**



### **IMPORTANT NOTES:**

- Although the Load Cradle (Left Side) is designed to handle heavy rolls up to 36 inches in diameter, the Roll Up Cradle (Right Side) in its Normal position is designed to accept rolls only up to 24 inches in diameter. However, for larger rolls, you can shift the Right Hand Side Cradle to its Expanded Cradle position. In this expanded position, the Right Hand Side Cradle can now handle larger rolls (up to approximately 32 inches in diameter). **ATTEMPTING TO ROLL UP ROLLS LARGER THAN THIS CAN CAUSE SERIOUS DAMAGE TO THE MACHINE AND IS NOT RECOMMENDED!**
- The roll capacities noted above along with the machine's overall performance will vary depending on the roll's weight, how tightly it is rolled, and whether or not it is slightly compressed or oblong around it's circumference.

## **REVERSE ROLLING PROCEDURES**

When **REVERSE ROLLING** the carpet, follow the instructions listed in the **MAIN OPERATING PROCEDURES** section for **LOADING THE ROLL OF CARPET**, **PREPARING TO MEASURE** and **PROGRAMMING THE COUNTER**. Follow the instructions below for **STARTING THE ROLL UP PROCESS**, **ROLLING UP THE CARPET** and **MEASURING THE TAIL END OF THE CARPET** because they are done differently than previously listed. Then refer back to **ROLLING THE CARPET STRAIGHT**, **CUTTING THE CARPET** and **REMOVING THE ROLLS FROM THE MACHINE** as previously illustrated in the **MAIN OPERATING PROCEDURES** section of this manual.

- When Reverse Rolling or Back Rolling carpet, a cardboard core (no wider than 4 inches in diameter) **must** be used.
- With both Rollers in FWD, advance the carpet onto the Right Hand Side Cradle bringing the edge of the carpet to rest at about the middle of the cradle.
- Place your core into the cradle and flip the carpet up so it rests on top of and covers the left half of the core.
- Engage the Right Hand Side Cradle by raising it up and folding the cradle over the carpet so it pinches the carpet up against the core.



## ROLLING UP THE CARPET

➤ With the carpet pinched in place and the Roller Speed in LOW, switch the Right Hand Side Rollers to REV and keep the Left Hand Side Rollers in FWD.

➤ Tap the Jog Button until the carpet starts to wrap itself around the core and completes about 3/4 of its first turn.

➤ At this time, lift up on the Reverse Roll Pressure Plates Handle located to the right of the main control panel. This will engage the series of stainless steel plates that run the length of the machine near the middle of the Right Hand Side Cradle.

➤ While gently holding this Handle in place, press the Jog Button to continue the advancement of the carpet. You will only have to hold the Handle in place for 1 or 2 seconds at which time you will see the plates actually force the carpet around the core. Once you see the carpet is starting to wrap around the core, release the Handle to its original position.

**NOTE:** If you are working with a stiffer backed carpet you may get better results by tapping the Jog Button instead of pressing and holding it down.

➤ Continue to press the Jog Button or Foot Switch Tape and hold the Right Hand Side Cradle in the folded up position until you get 3 to 5 turns on the core, then return the Right Hand Side Cradle to its original **normal** locked position.

➤ Adjust the Roller Speed to whatever you prefer.



## **NOTES:**

➤ Remember the difference between using the Jog Button and the Foot Switch Tape with respect to the Pre-set programmed length - using the Jog Button will override this feature.

➤ Again, if the carpet buckles slightly during the initial start-up, you can eliminate this buckling by momentarily stopping the Left Hand Side Rollers and then quickly turning them back to FWD.

➤ **Reverse rolling takes a little more practice and patience, take your time and don't give up.**

## MEASURING THE "TAIL END" OF THE CARPET

- You must remember that when measuring a full or partial roll, you have to take into account the last section or "tail end" of carpet that doesn't get measured by the Counter after the material passes over the Counting Wheel. Using a tape, measure the section of material between the back edge of the carpet and the Cutting Track, and add it to the amount that is already recorded on the Counter's Screen.
- To set your Counter to measure a full roll of carpet follow the "MEASURE ONLY" instructions on page 29 of this manual.

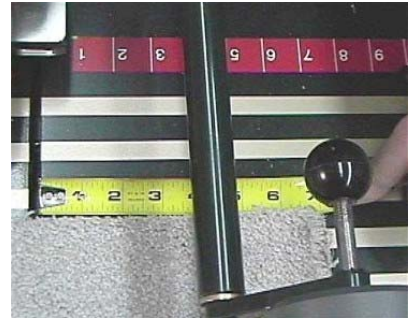

## VINYL PROCEDURES

- **Although Vinyl flooring can be handled in the same fashion as previously detailed in the carpet procedures, some of these exceptions or options may apply:**
- Instead of loading the roll on the Left Hand Side with the edge coming up from the **Bottom**, you can also load the material with the edge coming over the **Top** with the "**Pattern**" facing up. In order to advance the vinyl across to the Right Hand Side, you will have to switch the Left Hand Side Rollers into REV and provide a little more manual assistance to help the material get started. This is a little tougher procedure and takes practice, but will obviously enable you to detect any flaws or damage to the vinyl's surface during operation.
- To avoid damaging your resilient vinyl flooring, we do not recommend using the "Dumping" mechanism on the machine's Right Hand Side. Dropping the roll to the floor from the machine's cradle can cause damage to the flooring, even if it is wrapped correctly. The use of a lift truck or manually by one or two employees is recommended for removing the roll from the machine.

## CARPET SHUTTLE CONTROL SYSTEM

➤ The MK10 is equipped with a Carpet Shuttle System that allows the operator to control the position of the carpet roll. You can use this feature in either **Manual** or **Automatic Settings** to adjust the front to back alignment of the carpet roll to prevent walking and/or coneing.

### MANUAL CARPET SHUTTLE CONTROL SETTING

➤ In order to use the **Cross Feeder System** manually, the “SHUTTLE” tab on the “EZ ACTION” Screen must read “MANUAL”. When activated, the **Cross Feeder Switch** will engage the pneumatically controlled Carpet Shuttle Control arms located in the middle of the Load Side Cradle. This feature will actually "twist" the roll of carpet that is in the Load Side Cradle so as to shift it from the back of the machine towards the front, or vice-versa, depending on which way you turn the switch. This will aid the roll-up of your carpet in the event that you have a roll that tends to telescope or walk. When the switch is released, the arms will return to their normal centred position.



#### NOTES:

- Once you learn this feature, you will notice that you do **not** have to activate the **Cross Feeder Switch** for a very long time in order to cause the roll to shift accordingly.
- Practice on this feature with a smaller roll until you become accustomed to how it works and prior to utilizing it during a "real" measure and/or cut.
- **Do not hold and activate the Cross Feeder Switch for a continued and/or excessive length of time, especially on larger rolls, as it can cause damage to your machine's motors and shuttle system.**





## AUTOMATIC CARPET SHUTTLE CONTROL SETTING

➤ When the **Shuttle** tab on the EZ ACTION Screen reads "**AUTO**", the Carpet Shuttle Control arms will automatically engage to shift the carpet as it comes across the table. The "**AUTO**" control uses the two "Photo Sensor Eyeholes" that are located on the top of the table between the counting wheel and the control panel. These "Eyes" sense the edge of the carpet and automatically adjust the control arms to ensure the carpet edge stays in between the two and comes across straight.

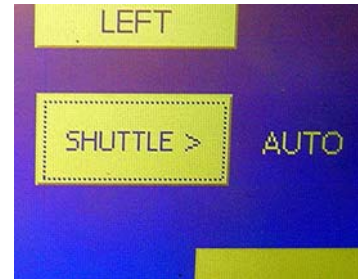

### IMPORTANT NOTES:

- **The carpet edge must always be positioned and lined up between the two “Eyes” prior to beginning a measurement.**
- **The Automatic Cross Feeder Control System will not work well if the carpet you are measuring has a salvage edge or if the “Eyes” are dirty or covered with debris. These situations will cause the Photo Sensor Eyes to react improperly and thus cause the carpet to move erratically.**
- **The “AUTO” feature should not be used in High Speed.**
- **Because the Automatic Cross Feeder Control System can be disorienting for new users, we recommend that it not be used until the operator is skilled in using the Cross Feeder System in the Manual position.**

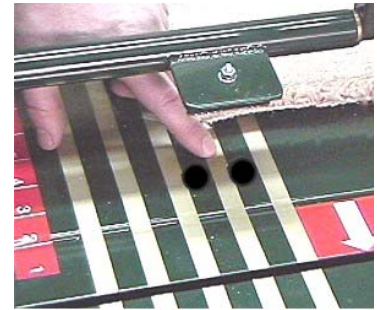

## **IMPORTANT SAFETY AND MAINTENANCE TIPS**

- **USE EXTREME CAUTION AND CARE WHEN OPERATING THE MACHINE AT ALL TIMES. KEEP THE OPERATING AREA CLEAR OF ALL UNAUTHORIZED PERSONNEL AND POTENTIAL HAZARDS. YOUR "E-Z CUT" IS A MACHINE NOT A TOY, NEVER ALLOW CHILDREN NEAR IT!**
- **WHEN PERFORMING ANY MAINTENANCE WORK ON THE MACHINE, ALWAYS DISCONNECT THE MACHINE FROM BOTH ITS POWER SOURCE AND AIR SUPPLY.**
- **ALWAYS MAKE SURE THE MACHINE IS LEVEL DURING OPERATION. AN UNLEVEL MACHINE MAY CAUSE CONING AND WALKING OF THE MATERIAL, AND DAMAGE TO THE MACHINE MAY OCCUR.**
- **DO NOT RAISE THE MACHINE ONTO ITS WHEELS OR MOVE IT WHILE LOADED, DAMAGE TO THE MACHINE MAY OCCUR.**
- **BE SURE TO USE EXTRA CARE AND CAUTION WHEN LOADING OR UNLOADING ROLLS ON THE LEFT HAND SIDE CRADLE TO AVOID DAMAGING THE SHUTTLE LOCATED IN THE MIDDLE OF THE CRADLE.**
- **WHEN HANDLING LARGER OR HEAVIER ROLLS, DO NOT USE "HIGH" SPEED. ONLY OPERATE IN THE "LOW" OR "MEDIUM" SPEEDS.**
- **WHEN THE MACHINE IS NOT IN USE, SWITCH BOTH ROLLERS TO "OFF" AND ENGAGE YOUR "EMERGENCY STOP BUTTON". DISCONNECT THE MACHINE FROM ITS POWER SOURCE WHEN LEFT OVERNIGHT.**
- **IN THE EVENT OF AN ELECTRICAL STORM, THE MACHINE SHOULD BE UNPLUGGED TO PREVENT POTENTIAL DAMAGE TO THE ON-BOARD ELECTRONIC EQUIPMENT.**
- **WHEN THE MACHINE IS NOT IN USE, ALWAYS KEEP THE "COUNTER WEIGHT ARM" (LOCATED DIRECTLY ABOVE THE COUNTING WHEEL) IN THE "UP" POSITION.**
- **THINK BEFORE YOU ACT AND USE COMMON SENSE! SHOULD YOU BE UNSURE WITH ANY OF THE MACHINE'S OPERATING FEATURES, CALL OUR OFFICE DIRECTLY AT TOLL FREE 1-800-661-5156.**

## **ROUTINE MAINTENANCE SCHEDULE**

### **DAILY:**

- Check for any oil leakage from the gearboxes. If there is a leakage, discontinue the use of the machine and call E-Z CUT immediately
- Use an “Air Pressure Hose” or a “Heavy Duty Vacuum Cleaner” to clean out floor covering residue, fibres, and dust build-up from the surface of machine. Pay extra attention to both of the Cradles, the Cradle Belts and the Cutting Track.
- Ensure that the 2 O-rings on the Counting Wheel are in good condition and that the Top Pressure Wheel is putting good downward pressure on the Counting Wheel. See pages 21 and 25.

### **BI-WEEKLY:**

- Clean Under Front and Back Cutting Track Cover Plates by removing the cover plates and cleaning out floor covering residue, fibres, and dust build-up.
- Make sure there is no substantial grease leakage from the Cutting Tracks Air Cylinder.
- Check that the screws that secure the Bladeholder to its base are snug.

### **SCHEDULE “A” MAINTENANCE: (Perform Schedule “A” Maintenance after the first 3 and 6 months of operation and then every 6 months thereafter):**

- Use the 1/8-inch and 5/32-inch Set Screw Wrenches (found in the back of this manual) to check that all visible Set Screws are tight. Pay particular attention to each Roller Bearing and each Gearbox Shaft.
- The fourth Roller from the left (when facing the machine at the control panel) has a small access hole located at the back end of it. Insert the 1/8 inch Set Screw Wrench into the hole and ensure that the Set Screw inside is tight.
- Check all Bearing Holder Bolts and Nuts.
- De-grease Cradle Locking Positions on Roll-Up side.
- Grease all Caster Wheels.

### **SCHEDULE “B” MAINTENANCE: (Perform Schedule “B” Maintenance yearly):**

- Change the oil in the Gearbox (refer to page 20 of this manual).
- Check the Cutter's Cable tension by first positioning the Cutting Bar at the far end of the machine and removing the top cover panel at the front of the machine. Press down on the portion of Cable that is just past the front pulley. There should be about .5 to 1 inch of 'play' in the Cable. If there is more 'play' in the Cable or it appears very loose, contact an E-Z CUT representative immediately.

### **NOTES:**

- The Roller Bearings are factory greased and **do not** require regular greasing.
- **In order to maintain your machine's optimum performance and to ensure any potential machine problems are covered under the "E-Z CUT WARRANTY", the above procedures**

**must be followed and adhered to at all times.**

## RECORD OF MAINTENANCE

<b>Record Date of Delivery:</b>			
<b>Length Of Time Since Delivery:</b>	<b>Maintenance Required:</b>	<b>Maintenance Performed By:</b>	<b>Date:</b>
<b>3 Months</b>	<b>Schedule A</b>		
<b>6 Months</b>	<b>Schedule A</b>		
<b>1 Year</b>	<b>Schedule A And B</b>		
<b>1 Year 6 Months</b>	<b>Schedule A</b>		
<b>2 Years</b>	<b>Schedule A And B</b>		
<b>2 Years 6 Months</b>	<b>Schedule A</b>		
<b>3 Years</b>	<b>Schedule A And B</b>		
<b>3 Years 6 Months</b>	<b>Schedule A</b>		
<b>4 Years</b>	<b>Schedule A And B</b>		
<b>4 Years 6 Months</b>	<b>Schedule A</b>		
<b>5 Years</b>	<b>Schedule A And B</b>		
<b>5 Years 6 Months</b>	<b>Schedule A</b>		
<b>6 Years</b>	<b>Schedule A And B</b>		
<b>6 Years 6 Months</b>	<b>Schedule A</b>		
<b>7 Years</b>	<b>Schedule A And B</b>		
<b>7 Years 6 Months</b>	<b>Schedule A</b>		
<b>8 Years</b>	<b>Schedule A And B</b>		

### IMPORTANT NOTES:

- Always perform the daily and bi-weekly maintenance in addition to following this long-term maintenance schedule
- Continue to perform scheduled maintenance for the life of the machine.

## **GEARBOX OIL REPLACEMENT**

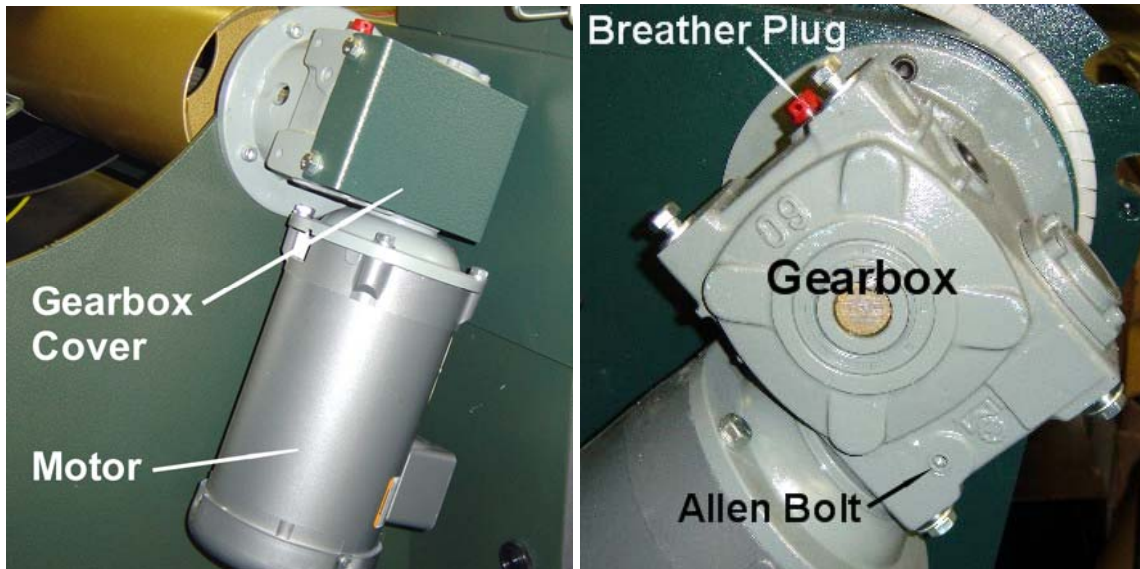

**IMPORTANT NOTE:** The Counter on your machine is programmed to remind you to change the oil after the machine has been used for a set amount of hours. The oil must be changed when this message comes up or once a year - whichever comes first.

Use approximately 9 - 11 ounces of oil per gearbox for your MK-7. Due to the mounting configuration, the window on the gearbox cannot be used to monitor the amount of oil however you must ensure that the gearbox is never more or less than half filled with oil at all times! Quaker State Synthetic Gear Oil is recommended but any brand between 75W to 90W Synthetic Gear Oil or Synthetic High Pressure Gear Oil is acceptable.

1. Disconnect the electrical power supply to your machine.
2. Remove the gearbox cover. Cover the motor with a rag so oil does not seep into it. Remove the bottom front Allen bolt to drain oil. Ensure that the Allen bolt is put back in place when done draining.
3. Remove the red breather plug on top of the gearbox and fill with about 9 - 11 ounces of oil. Ensure that the gearbox is about half filled with oil and reinstall the top breather plug and the gearbox cover.
4. Repeat steps 1, 2 and 3 to change the oil in the gearbox on the opposite side of the machine.
5. Ensure all plugs are in place, remove the rag from both motors and reinstall both gearbox covers before reconnecting the power and operating the machine again

## **TROUBLE SHOOTING MEASURING ACCURACY PROBLEMS**

- Refer to the Operators Manual to ensure the correct operating procedures are being followed.
- Ensure the Counter is set for the right type of carpet.
- Ensure all operators are using the machine in the same manner and fashion.
- Ensure that the 2 black rubber O-rings on the Wood Counting Wheel are both present and in good condition.
- Before running the carpet across the Cutting Track, make sure the Top Pressure Wheel is in the down position and putting good downward pressure on the Counting Wheel. If the Top Pressure Wheel is not pressing down on the Counting Wheel follow the instructions on page 25.
- Always measure the material with the Backing Side Down and Pile Side Up.
- Make sure to always line up the material with the Cutting Track and reset the Counter to “0.00” (zero) before attempting to measure.
- If you are measuring a full or balance roll, make sure to set the Counter to Measure Only (see page 29) or to add the “Tail End” of the carpet to what the Counter Screen is showing because this “Tail End” amount will not be measured by the Counter once it passes over the Counting Wheel.

### **IMPORTANT NOTE:**

**Please note that your Counter will react slightly different to various material backings (i.e. jute, actionback, rubber, foam (kanga), enhancer, unitary, etc.) and/or thickness. Your Counter has four preprogrammed settings for Residential, Commercial, Kanga and Vinyl. If the carpet you are using doesn't fit into any of these categories you can set it as one of up to four Programmable Options. See page 24 for detailed instructions on Calibrating Your Options.**

## **MEASURING ACCURACY TESTS**

If the machine is still not measuring accurately after going through the Trouble Shooting list follow these instructions in order to Benchmark the Accuracy of your Machine:

1. **Make a Photocopy of tests located on the next page.**
2. Perform the described tests and **record** your results.
3. If the tests indicate a possible problem with the calibration **Fax** the results along with your name, phone number, company name and location to **(204) 237-9339**.
4. After reviewing the results an E-Z Cut representative will get in touch with you to assist you

in resolving the problem.

Date:	Phone#:
Company Name and Location:	Your Name:

**ENCODER TEST**

1. Make a mark or line on both the Counting Wheel and the Table, and line them up.
2. **Reset the Counter to “0.00”.**
3. Turn the Counting Wheel by hand one complete rotation so that the marks on the Counting Wheel and the Table line up. Record the length indicated on the Counter Screen in the box below (i.e. 2.00).
4. **Reset the Counter to “0”** and repeat step #3 about 15 to 20 times. In each case be sure to **record** the Counter Reading in the box below and then **Reset the Counter to “0”**.

<b>1.</b>	<b>2.</b>	<b>3.</b>	<b>4.</b>
<b>5.</b>	<b>6.</b>	<b>7.</b>	<b>8.</b>
<b>9.</b>	<b>10.</b>	<b>11.</b>	<b>12.</b>
<b>13.</b>	<b>14.</b>	<b>15.</b>	<b>16.</b>
<b>17.</b>	<b>18.</b>	<b>19.</b>	<b>20.</b>

**NOTE: If the same reading comes up each time, your encoder is operating properly.**

**MEASURING ACCURACY TEST**

1. Select a roll of material (35’ or longer) that you use most often and unroll it on the floor.
2. Using a Tape Measure, start at one end (make sure the end you start from is square) and make a mark on the backing at exactly 5’ increments all the way to 30’.
3. Roll up the material and load onto the machine.
4. Position the starting end of the carpet exactly on the Cutting Track and **Reset the Counter**.
5. Set Your Counter to the type of carpet being tested.
6. Advance the material and stop with the 5’ mark exactly on the cutting track. **Record the Counter reading** in the Table below. Continue for every 5’ increment up to and including 30’ (make sure the material is rolling up straight).

<b>Record Material Type And Weight:</b>	
<b>5’</b> _____ , _____ ”	<b>20’</b> _____ , _____ ”
<b>10’</b> _____ , _____ ”	<b>25’</b> _____ , _____ ”
<b>15’</b> _____ , _____ ”	<b>30’</b> _____ , _____ ”

1. Re-roll the roll to its starting position with the starting end exactly on the cutting track and **Reset the Counter**
2. This time, advance the material but do not stop until the 30’ mark is exactly on the Cutting Track. **Record the Counter reading** in the Table below.
3. Repeat this five or six times to determine consistency.

<b>1. 30’</b> _____ , _____ ”	<b>4. 30’</b> _____ , _____ ”
<b>2. 30’</b> _____ , _____ ”	<b>5. 30’</b> _____ , _____ ”
<b>3. 30’</b> _____ , _____ ”	<b>6. 30”</b> _____ , _____ ”

**FAX RESULTS TO 204-237-9339**



## **CALIBRATING OPTIONS ON YOUR TOUCH SCREEN COUNTER**

This feature allows you to automatically Calibrate an Option for up to four specific carpet types of your choosing. This ensures exact measurements on the Calibrated carpet every time. These **“Programmable Options”** are in addition to the four Factory Presets (Residential, Vinyl, Commercial and Kanga). **It is strongly recommended that a record of the types of carpet that have been Calibrated be kept.**

### **1) Prepare the type of carpet that you would like to Calibrate:**

1. Measure out **at least a 35'** piece of the carpet on the floor and make a mark at **exactly 30' long**.
2. Load the roll on the machine, advance the edge to the cutting track and lower the counter weight arm.

### **2) Follow these steps to get to the AUTO SCALING Screen:**

1. From the MAIN MENU Screen press the **“SETTINGS”** Button.
2. Press **“AUTO SCALE”** Button from the SETTINGS Screen.

### **3) From the AUTO SCALING Screen follow these steps to Calibrate each Option:**

1. Reset the Counter to **“0”**.
2. Select the desired Roller Speed.
3. Key in **30' 0”** by pressing the foot/inch buttons to bring up the keypad.
4. Select any one of the 4 OPTIONS by pressing the corresponding button.
5. Using either the JOG button or Foot Switch Tape, advance the roll and stop it exactly on the mark you made at 30'.
6. Press the **“SAVE”** button to lock in the new setting. The OPTION you chose is now calibrated to for this material.
7. Record the type of material that has been Calibrated for the Option Number in an **“OPTIONS LOG”** such as the one found on the next page.

### **4) Check and Verify:**

1. Roll the carpet back to the Load (Left) side of the machine.
2. From the MAIN MENU Screen press the **“CUT”** Button.
3. Select the Option Number that you have Calibrated for this carpet.
4. Advance the edge of the carpet up to the cutting track. Lower the counter weight arm and reset the counter to zero.
5. Run the carpet up to the 30' mark to ensure it is measuring correctly.

**NOTE: Calibrated Options may be lost if the machine is without power for more than 48 hours.**

<b>PROGRAMMABLE OPTIONS LOG</b>			
<b>OPTION</b>	<b>TYPE OF CARPET</b>	<b>OPERATOR</b>	<b>DATE</b>
<b>OPTION 1</b>			
<b>OPTION 2</b>			
<b>OPTION 3</b>			
<b>OPTION 4</b>			

## ADJUSTING THE COUNTER PRESSURE WHEEL

If the Top Pressure Wheel is not pressing down on the Counting Wheel follow these instructions to adjust it into the proper position.

- 1) Disconnect the Machine from the power supply.
- 2) Remove the Allen bolts from the Top Control Panel in order to slide it to the side. This should give you access to the Counter Weight Bracket.
- 3) Use a 7/16" Wrench to loosen the Bolt on the top left side of the Counter Weight Bracket.
- 4) Push the grey Top Pressure Wheel into the down position.
- 5) Insert a large Flathead screwdriver between the right side of the Counter Weight Bracket and the edge of the Wiring Box. This procedure will allow the shock to apply the necessary pressure to the Counting Wheel without hitting the side of the Wiring Box.
- 6) Re-tighten the top Bolt and remove the screwdriver.
- 7) If necessary re-install the Counter, plug in the Wiring Clips, and re-attach the plastic Clip Plates and Phillips screws.
- 8) Re-install the Front Access Panel and the Top Control Panel.

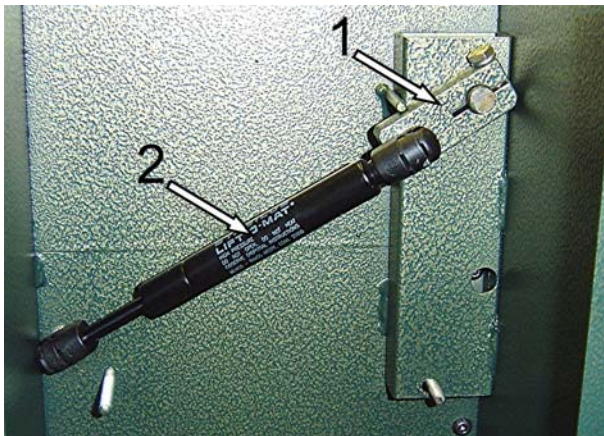

➤ This photo of a Machine (with the Counter and Switches removed) shows the Counter Weight Bracket (#1) lined up with the Shock (#2) at a 45 degree angle. This is what the assembly should look like with the Counter Weight Wheel in the **UP** position.

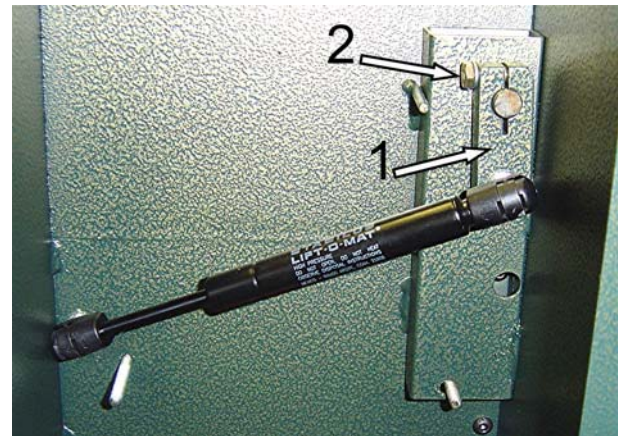

➤ This photo shows the position the Counter Weight Bracket (#1) should be in with the Counter Weight Wheel in the **DOWN** position. To make your adjustment loosen the Bolt (#2) and put your Counter Weight Wheel Down so the Bracket is in this vertical position.

## **BLADEHOLDER INSTRUCTIONS**

- Remove the Setscrews with the 5/32 Allen wrench found at the back of the operating manual.
- Lift and remove the top portion of the Bladeholder
- Remove the Blades by sliding them out of the slots.
- With the Blades removed, clean out any carpet debris or fibers from both, the top and bottom portions of the Bladeholder.
- Rotate the old Blades to a fresh corner or dispose of them and replace with new Blades.
- Re-position the top portion of the Bladeholder and re-secure it into place with the Setscrews.

### **NOTES:**

- Due to the configuration of the Bladeholder, you should be able to use all four corners of each Blade before disposing of them.
- The Setscrews on the Bladeholder should be checked to ensure that they are tight at least once a day. Activation of the Bladeholder coupled with numerous cuts can cause the Setscrews to loosen over time, which would result in your Bladeholder not performing as intended.

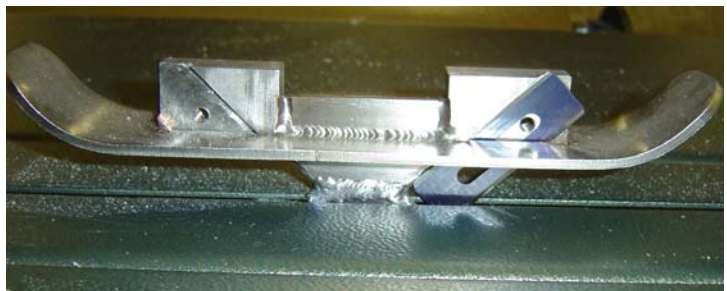
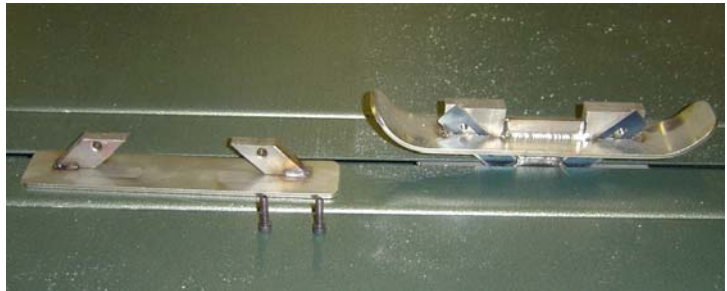
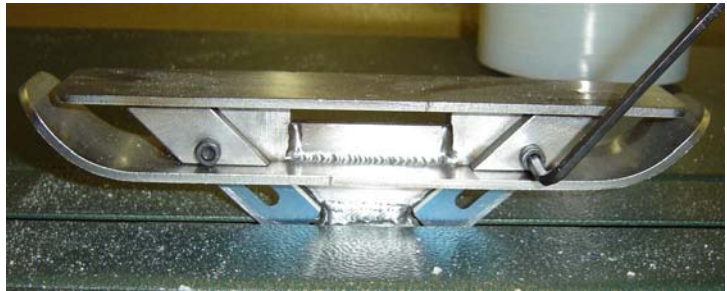

## OPERATING THE TOUCH SCREEN PANEL

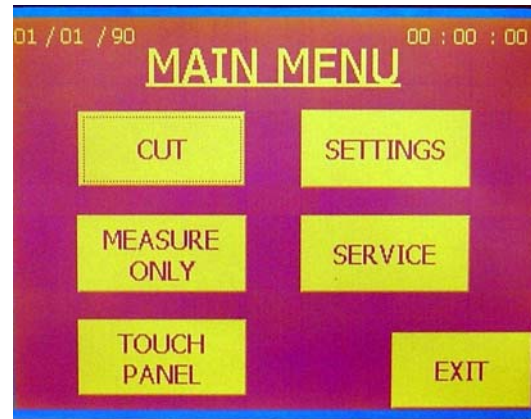

At start up the TOUCH SCREEN PANEL will display the boot up process and will then stop at the E-Z CUT MK 10 Screen. Simply press the ENTER button to bring up the MAIN MENU Screen. The Main Menu displays the five interface screens that give you access to all the functions of your MK10.

1. **CUT SCREEN**
2. **MEASURE ONLY SCREEN**
3. **TOUCH PANEL SCREEN**
4. **SETTINGS SCREEN**
5. **SERVICE SCREEN**

### 1 - CUT SCREEN

The CUT Screen gives you access to all of the most used features of the MK10.



➤ **TO MAKE A CUT**

1. Enter the desired length (feet and/or inches) by pressing the number box to the right of the PRESETS button.
2. Select the type of carpet being cut by pressing the arrows on either side of the MATERIAL label.
3. Press the button for the desired speed, LOW, MEDIUM or HIGH on the bottom left of the CUT SCREEN.
4. Press the EZ ACTION button to make sure the SHUTTLE is in the desired mode (MANUAL or AUTO).
5. Make sure the carpet is lined up with the Cutting Track.
6. Make sure the Counter Weight is lowered to the down position.
7. Press the COUNTER RESET button to set the counter to “0”.
8. Turn both Roller Switches to FWD.
9. Advance the roll using the Foot Switch Tape (the JOG button can also be used, but the machine will not automatically stop at the PRESET length).
10. When the machine stops, confirm the length displayed on the counter is correct. At this point the roll can be moved with the JOG button only, the Foot Switch Tape will not be functional until the Counter is reset.
11. When the roll is at the desired length, activate the Cutter using the appropriate button (FWD or REV, depending on which end of the Machine the Cutter is).



➤ **TO ENTER MULTIPLE PRESETS**

1. Press the PRESETS button on the CUT Screen
2. Manually enter the Presets one at a time. Enter the feet, inches and the corresponding Material Type for each Preset. The optional barcode scanner, which connects to the machine, can be used so no manual entry is required.
3. When done press the FINISHED button to return to the CUT screen.
4. Press the NEXT PRESET button to advance through the Presets one at a time.

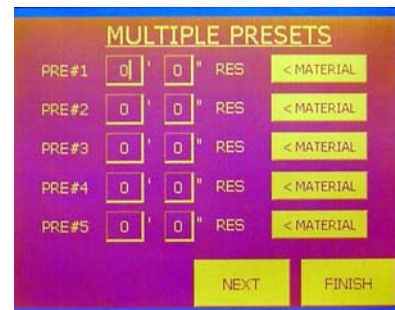

**Notes:**

- Presets are deleted once the next one is advanced.
- Presets are displayed first in first out.

## ➤ EZ ACTION SCREEN

Press the E-Z ACTION button at the bottom centre of the Cut Screen to bring up the EZ Action Screen. This Screen gives you quick access to these commonly used features.

- The LOAD FROM FEED TABLE button is used in conjunction with an EZ CUT FEEDING TABLE.
- To dump a roll from the left side cradle press and hold the DUMP LEFT button until the roll has been dumped.
- To wrap a roll in the right side cradle press the WRAPPING button, set the Right Side Rollers to FWD, select Roller speed and use the JOG button or Foot Switch Tape to toggle the Rollers.
- Press the SHUTTLE button to toggle between MANUAL and AUTO SHUTTLE.



## 2 - MEASURE ONLY SCREEN

The measure only feature allows you to measure a full roll of carpet with out making any cuts.

1. Press the MEASURE ONLY button on the MAIN SCREEN.
2. Select the type of carpet being measured.
3. Select the desired speed (LOW, MEDIUM or HIGH).
4. Make sure the carpet is lined up with the Cutting Track.
5. Make sure the Counter Weight is lowered to its DOWN position.
6. Press the COUNTER RESET button (the counter will display 7" to make up for the tail end of the carpet).
7. Set both Roller Switches to FWD.
8. Advance the roll using the Foot Switch Tape or the JOG button until the end of the roll is past the Counter Wheel
9. Record the reading on the Counter.



## 3 - TOUCH PANEL SCREEN

The TOUCHPANEL SCREEN provides maintenance tools to allow you to CALIBRATED, CLEAN and adjust the CONTRAST on the TOUCHSCREEN. Simply press the button for the desired task and follow the on screen instructions. You can also access the TOUCH PANEL SCREEN from the SETTINGS SCREEN.

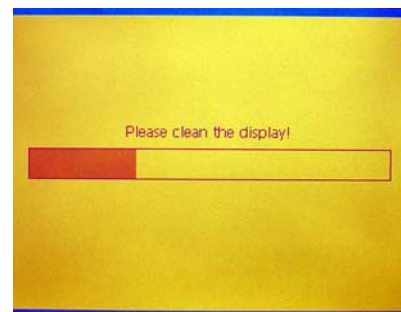
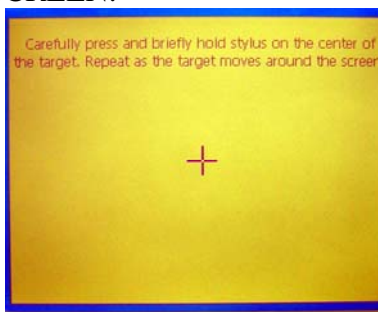

## 4 - SETTINGS SCREEN

The settings screen provides access to all the advanced functions of your machine. You must enter the MASTER PASSCODE (**Factory Default is 1234**). To access the SETTINGS SCREEN press the SETTINGS button to bring up the ENTER PASSCODE SCREEN and enter the PASSCODE (**1234**).

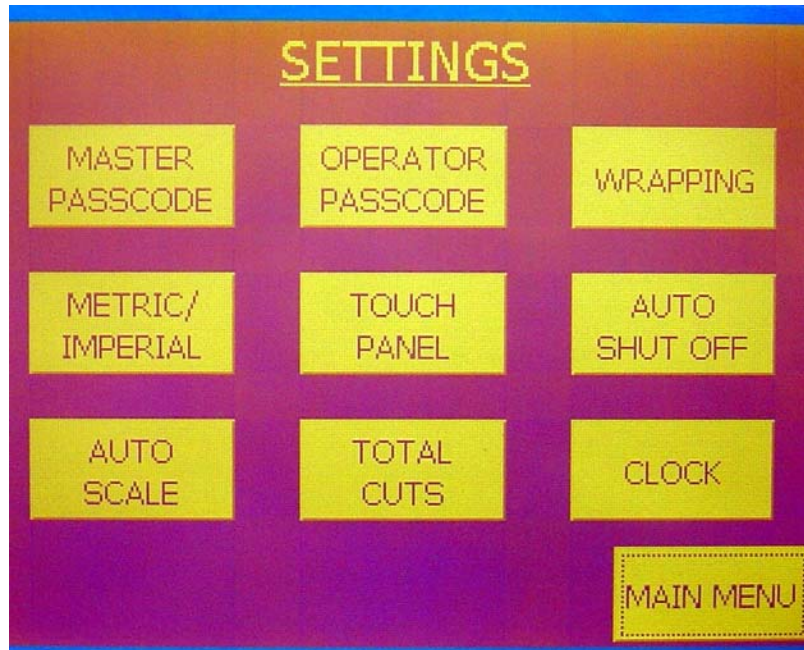

### MASTER PASSCODE BUTTON

➤ The MASTER PASSCODE is set at the factory for “1234” and can be changed on this screen. **This is a higher level of security than the pass code and it is highly recommended that you leave this feature as is.**

**IMPORTANT NOTE: IF THE MASTER CODE IS CHANGED AND THAT CODE IS LOST THE E-Z CUT WILL BE UNABLE TO TROUBLESHOOT THE COUNTER IN ANYWAY!**

### OPERATOR PASSCODE BUTTON

➤ This feature allows you to enter a pass code for safety and security reasons. The machine will not be operable unless this pass code is keyed in. **DO NOT FORGET YOUR PASS CODE IF YOU CHOOSE TO USE ONE.**

➤ To change the OPERATOR PASSCODE press the button to bring up the keypad and enter the new OPERATOR PASSCODE.





### WRAPPING BUTTON

- This screen allows you to turn the WRAP Feature on and off.



### METRIC/IMPERIAL BUTTON

- This screen allows you to toggle between Imperial (feet and inches) and Metric (meters and centimetres) units of measurement.



### TOUCH PANEL BUTTON

See page 24 for a description of the maintenance tools found on the TOUCHPANEL SCREEN.



### AUTO SHUT-OFF BUTTON

- This feature allows you to set how long the machine will wait before shutting itself down when it sits idle. To set the time (factory default is 10 minutes), press the button to bring up the keypad and enter a new time between 1 and 250 minutes.



### AUTO SCALING BUTTON

- This feature allows the user to calibrate up to four Material Options in addition to the four factory default Material Types (Residential, Commercial, Kanga and Vinyl). Use this for carpet types that are not consistent with the factory settings. You can set your OPTIONS by following the detailed instructions found on pages 23 and 24.



## TOTAL CUTS BUTTON

➤ Your DAILY, WEEKLY and TOTAL CUTS are displayed on this screen. The DAILY and WEEKLY reset automatically (based on a Sunday to Saturday week). The TOTAL CUTS is cumulative and does not reset.

**Note:** These numbers increment for every operation of the Cutter, regardless of whether or not material was actually cut.



## CLOCK BUTTON

Press the SET CLOCK button on the CLOCK Screen to set the Date and Time. From this screen press the corresponding buttons to bring up the keypad. To set the day of the week, press the DAY OF WEEK button.



## 5 – SERVICE SCREEN

The Service Screen is only used by our Service Department to troubleshoot the machine.

# MK-7 PARTS LIST

## Control Panel

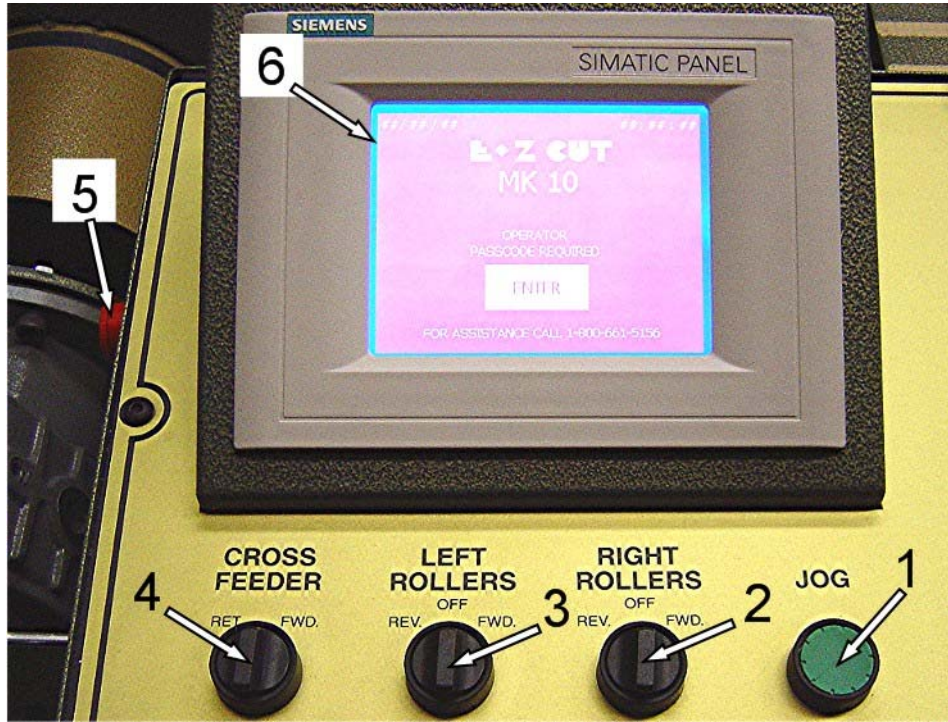

KEY	PART NUMBER	QTY	DESCRIPTION
1	9040-00054-A	1	Jog Button, Siemens
2	9040-00051-A	1	Right Roller Switch, Siemens, Locking
3	9040-00051-A	1	Left Roller Switch, Siemens, Locking
4	9040-00052-A	1	Cross Feeder, Ret/Fwd, Siemens, Spring
5	9040-00055-A	1	Emergency Stop Button, Siemens
6	9040-00010-A	1	Touchscreen Control Panel, Siemens, Simatic Panel

**Front And Top Of Machine - Motors And Belts**

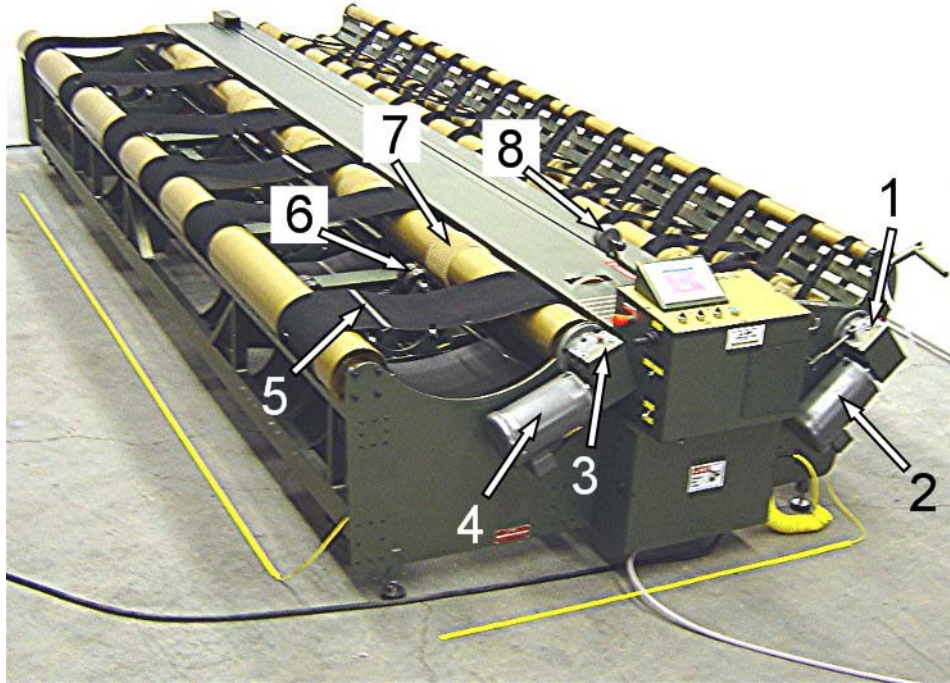

KEY	PART NUMBER	QTY	DESCRIPTION
1	EOVM50-50	1	Right Side Gearbox, 50:1
2	VM3116	1	Right Side Motor, Baldor, 1hp, 230v
3	EOVM50-60	1	Left Side Gearbox, 60:1
4	VM3116	1	Left Side Motor, Baldor, 1hp, 230v
5	See Belt List	30	Black Laced Belts, Right And Left Sides Of Machine
6	N/C	2	Shuttle Assembly, 1 In Front, 1 In Back
7	See Belt List	31	Tan Glued On Belts, Right And Left Sides Of Machine
8	N/C	1	Counter Weight Wheel

**Belt List – Measure Belt On Machine To Confirm Length And Width**

PART NUMBER	QTY	SIZE AND DESCRIPTION OF BELTS
CPUL12X77	5	Left Side Black Laced Belt, 12” Wide And 77” Long
CPUL4X51.25	11	Right Side Black Laced Belt, 4” Wide And 51.25” Long
CPUL2X51.25	1	Right Side Black Laced Belt, 2” Wide And 51.25” Long
CPUL4X36	11	Right Side Black Laced Belt, 4” Wide And 36” Long
CPUL2X36	1	Right Side Black Laced Belt, 2” Wide And 36” Long
RT6X22.25	4	Left Side Tan Glued On Belt, 6” Wide And 22.25” Long
RT1X17.5	27	Right Side Tan Glued On Belt, 1” Wide And 17.5” Long

**Front And Top Of Machine – Tapeswitch And Rollers**

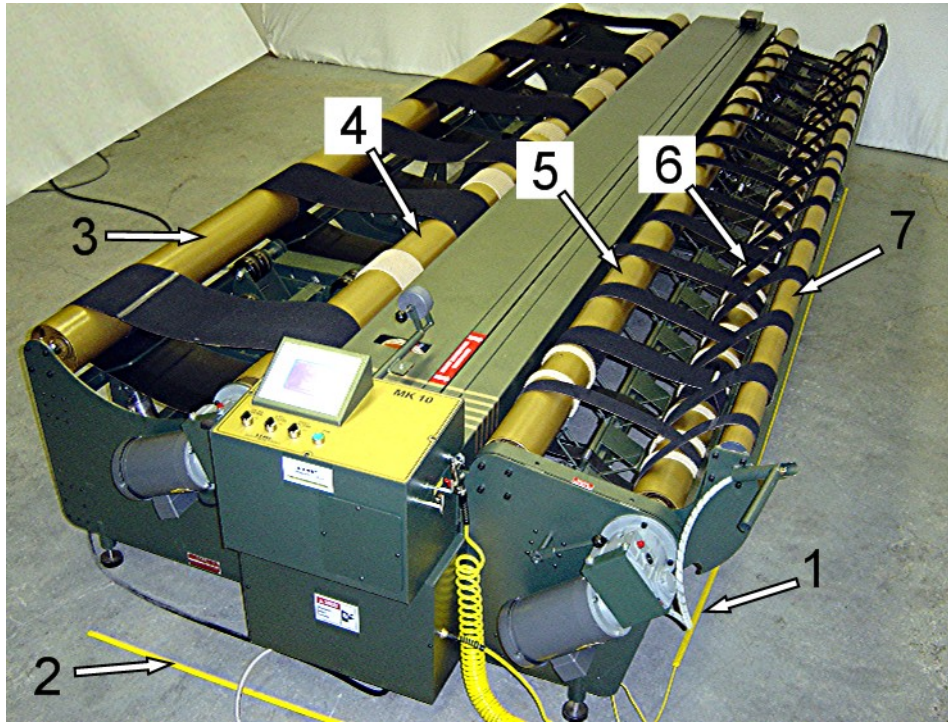

KEY	PART NUMBER	QTY	DESCRIPTION
1	9040-00002-A	2	11' Tapeswitch Pieces, Along Both Sides Of Machine
2	9040-00001-A	1	5' Tapeswitch Piece, Along Front Of Machine
3	ROLLER-#1	1	Outside Roller On Left Side
4	ROLLER-#2	1	Inside Roller On Left Side, Connected To Motor
5	ROLLER-#3	1	Inside Roller On Right Side
6	ROLLER-#4	1	Outside Roller On Right Side, Connected To Motor
7	ROLLER-#5	1	Small Rollup Roller On Right Side

**Front Right Side Of Machine**

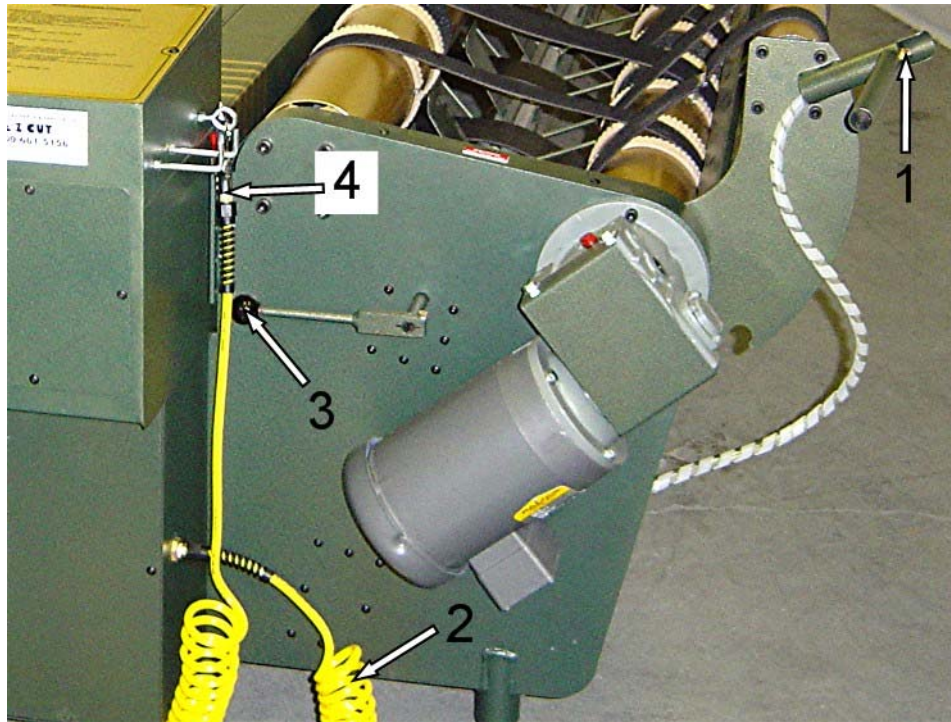

KEY	PART NUMBER	QTY	DESCRIPTION
1	9010-00015-A	1	Right Hand Side Cradle Arm Release Button/Valve
2	9010-00054-A	1	25' Coiled Yellow Air Hose
3	B-6	1	Reverse Roll Pressure Plates Screw On Knob
4	9010-00047-A	1	Compressed Air Blow Gun

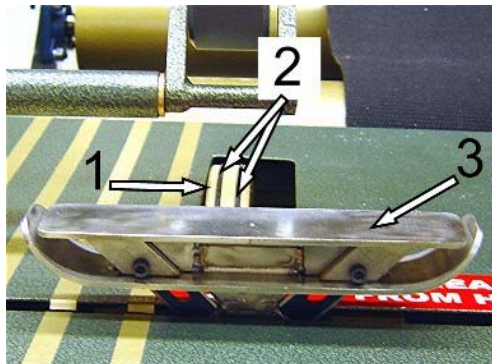

**Top Of Machine - Bladeholder And Counting Wheel**

KEY	PART NUMBER	QTY	DESCRIPTION
1	4010-00004-A	1	Counter Wheel
2	ORING	2	O-Rings
3	BH-MK7	1	Bladeholder

## Wiring Of Machine, Top Control Panel

Remove Allen Bolts And Flip Control Panel Up To Gain Access To Bladeholder And Underside Of Switches.

### Underside Of Control Panel

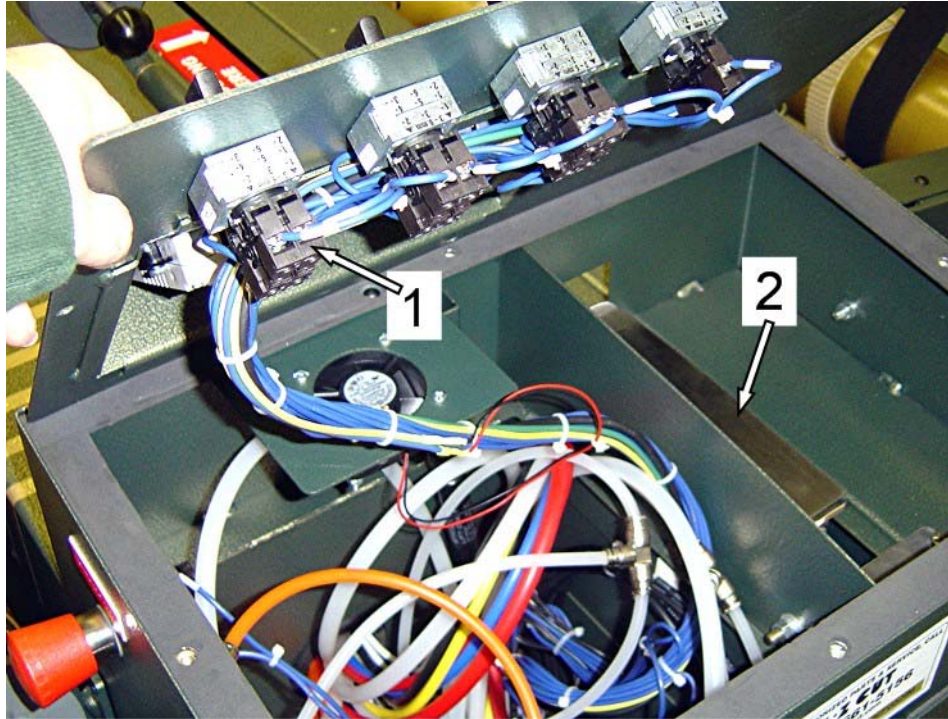

KEY	PART NUMBER	QTY	DESCRIPTION
1	Check # On Block	Varies	Contact Block For Switch, Siemens
2	N/C	1	Bladeholder Access

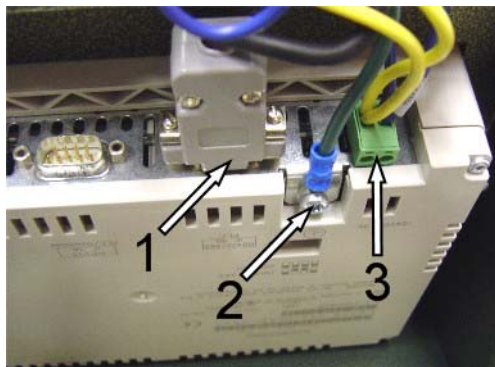

### Underside Of Touchscreen Counter

KEY	PART NUMBER	QTY	DESCRIPTION
1	N/C	1	PLC Connector Cord
2	N/C	1	Ground Wire
3	N/C	1	Power Connector Cord

**Wiring Of Machine, Bottom Access Panel Removed**

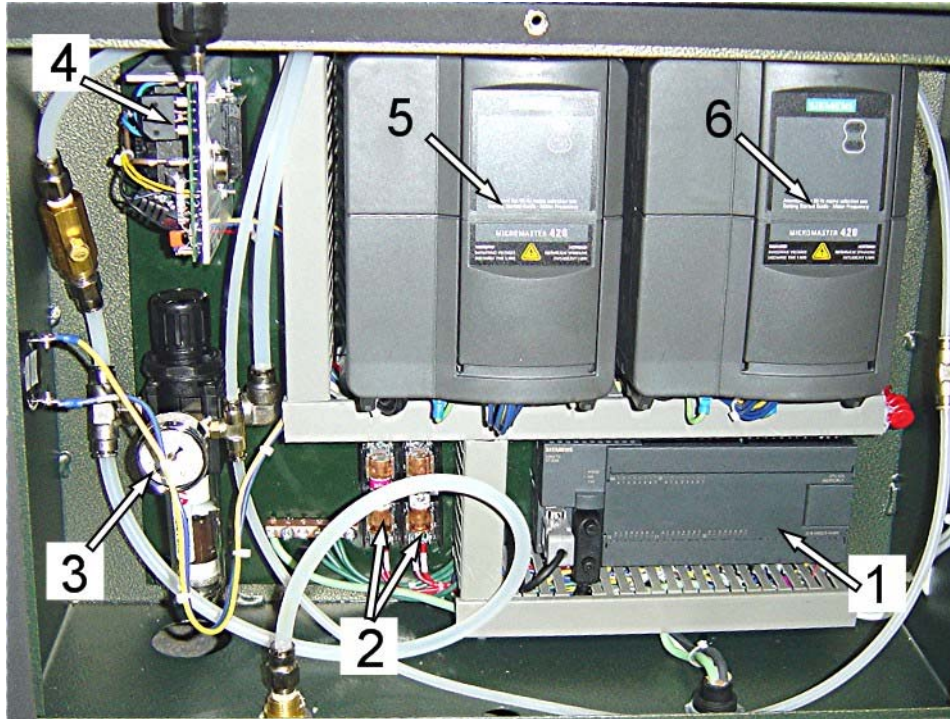

KEY	PART NUMBER	QTY	DESCRIPTION
1	PLC/226	1	PLC Controller, Siemens
2	N/C	2	Fuses, Check Amperage On Each Fuse
3	9010-000064-A	1	Air Filter/Regulator
4	N/C	1	Power Supply
5	MM420-1.0HP	1	Left Roller Drive, Siemens 1 hp
6	MM420-1.0HP	1	Right Roller Drive, Siemens 1 hp



## **WARRANTY**

E-Z CUT Inc. guarantees all E-Z CUT machines sold or leased to the original owner or lessee to be free from defects in workmanship and design, under normal operating conditions, for a period of three (3) years from the date of delivery. All electronic, electrical, electro-mechanical, pneumatic, and drive components (excluding Cradle Belts) are covered, under normal operating conditions, for a period of one (1) year from the date of delivery.

This limited warranty shall not apply to any defects resulting from, but not limited to, abuse, lack of maintenance, unauthorized modifications, overloading, power surges, inadequate power supply, or normal wear on parts and components. E-Z CUT Inc. reserves the right to repair or replace, at its own option, any defects found with the machine and/or its components, within the warranty period.

During the warranty period, E-Z CUT Inc. will ship replacement parts via normal ground freight, pre-paid to the owner/lessee. It is the responsibility of the owner/lessee to return all defective materials, freight pre-paid, to E-Z CUT Inc. within 30 days for warranty consideration. Any extra freight costs for special shipping, such as airfreight or expedited shipments, is the responsibility of the owner/lessee.

E-Z CUT Inc.'s liability under this warranty shall be solely limited to the repair and/or replacement of defective materials and shall not be liable, under any circumstances, for consequential or incidental damages, lost income due to downtime, personal injuries, damage to floor covering material, or associated labour costs, without the prior written approval from E-Z CUT Inc.